

6

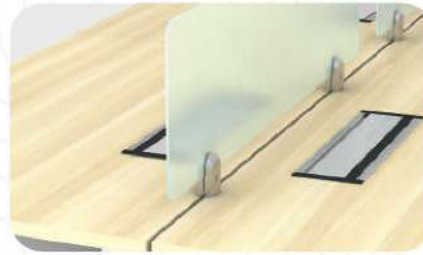

6-SANDBLAST DESIGN

16



16-CLIP DESIGN

18



18-POLE DESIGN



18-HANGING DESIGN



18-DESKING DESIGN

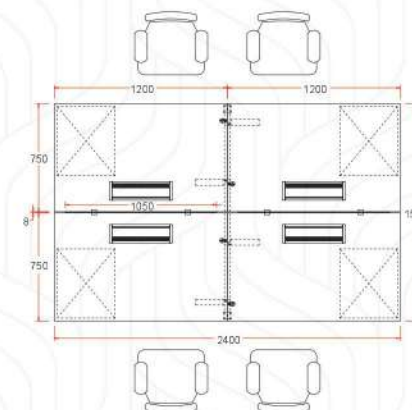

6-SR-4

Modern modular desking system that designed with sandblast panels to illuminate your interior to a comfortable feel.

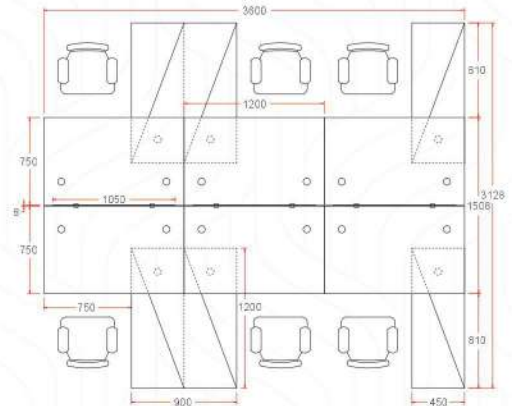

6-SR-6

Contemporary design of desking panels with storage that give you quality filing system for your association.

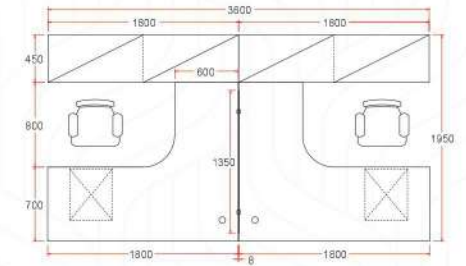

16-TOL-2

Sophisticated single panel workstation that enables both partners to have good collaboration in their tasks for higher achievement.

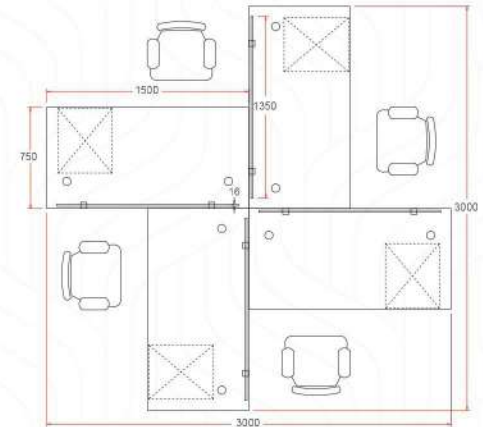

16-SR-4

The beauty of the windmill décor layout transform your office to have a working knowledge of wind energy concept.

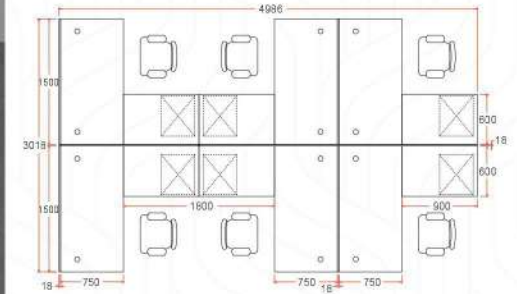
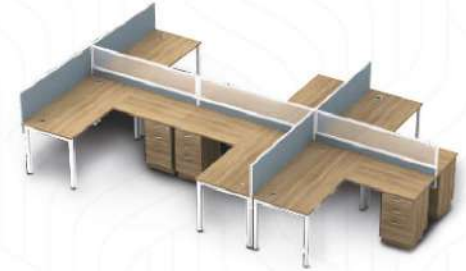

18-SL-6

Smart spacing design for each of the member in the room to own a L shaped desk.





18-PYR-4

Clean white aesthetics come with elegant pyramid aluminium leg creates an appealing office landscape for your workspace.

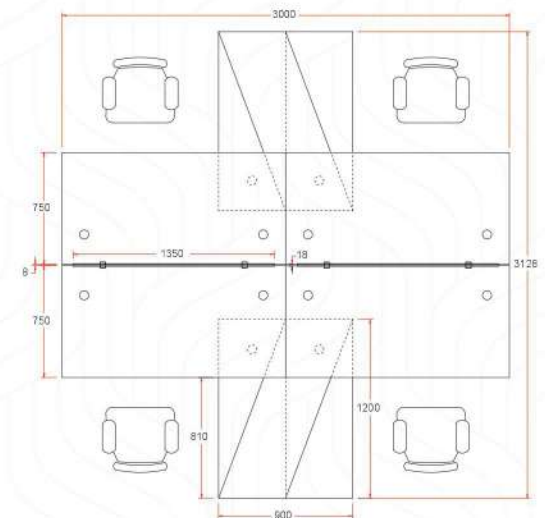

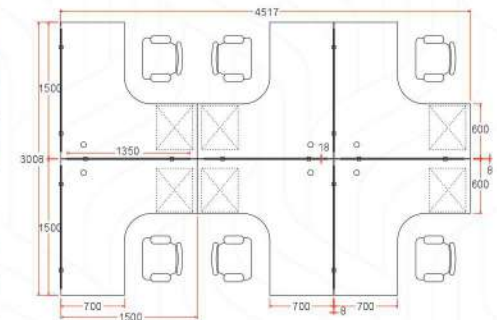
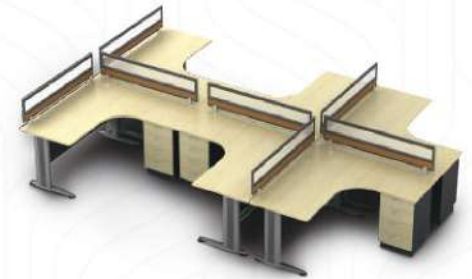

18-TL-6

A truly unique workstation solution that integrates L shaped desk and pedestals with desking panels.

30

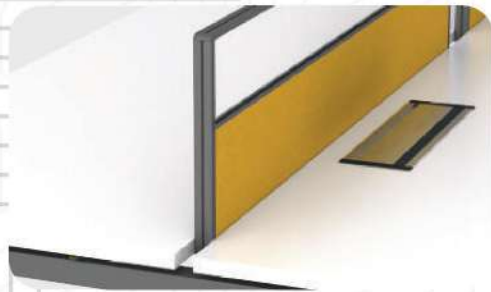

30-HANGING DESIGN



30-UNIVERSAL POLE DESIGN



30-BLOCK DESIGN

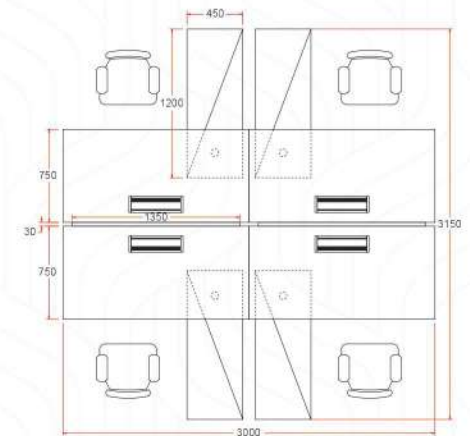
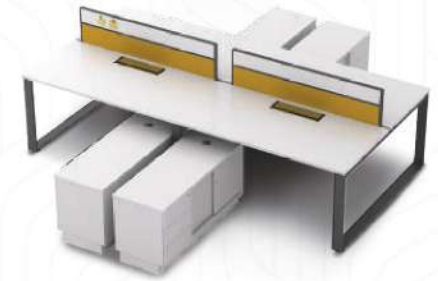

30-SQR-4

A workstation in white makes your working environment a clean & pure feeling that can represent a successful beginning. This set of softness and humanity symbolization comes with storage cabinets accompanied by the modern square legs.

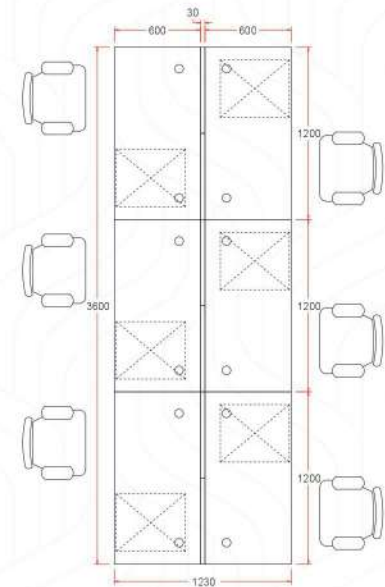

30-OR-6

Elegant and easy to assemble rectangular desk workstation allows you to fit perfectly your space.

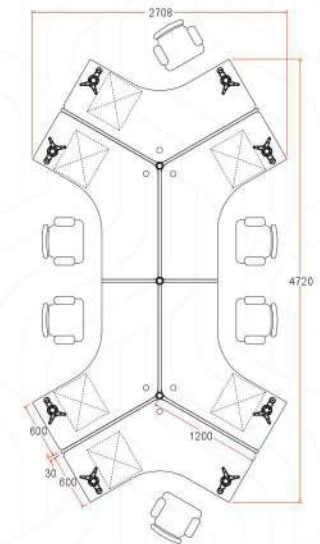
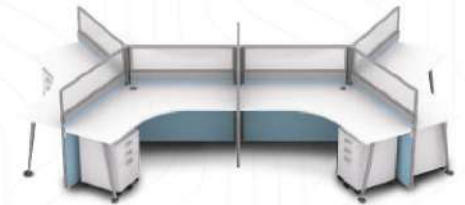

30-VIY-6

An optimised workplace promotes workers well being and performance. This workstation utilized most square metre of your office for an efficient way of working in a group.

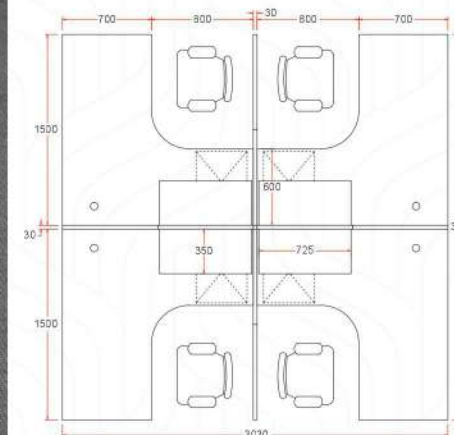

30-BL-4

This networking desk set has a good idea of connecting four people. Each of them may perform their daunting task in privacy mode.

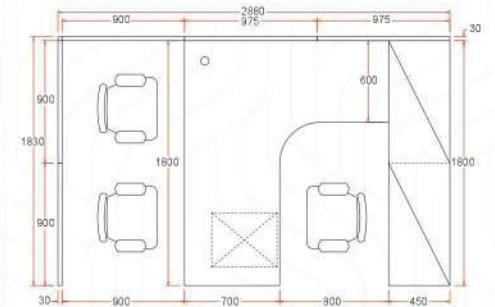

30-BL-1

A great privacy workplace for an executive to accomplish the important task. The full polycarbonate panel enhances picturesque visual to your office.

45



45-BLOCK DESIGN

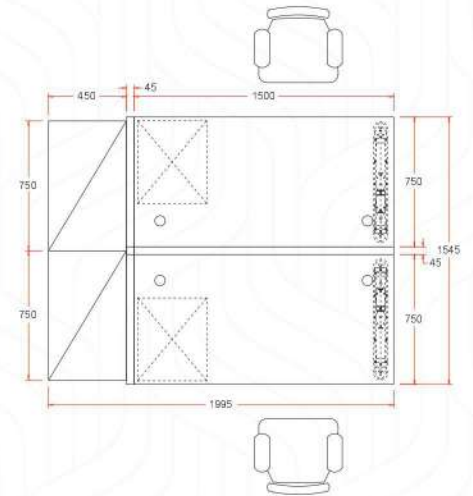

45-BR-2

The stylish T-system gives you aesthetic workplace for best collaborative work among the team members.

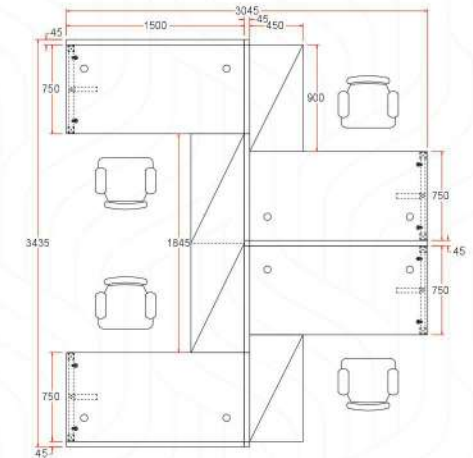

45-SR-4

For open concept system where cooperative work become essential, this would be the best choice to utilise your workplace.

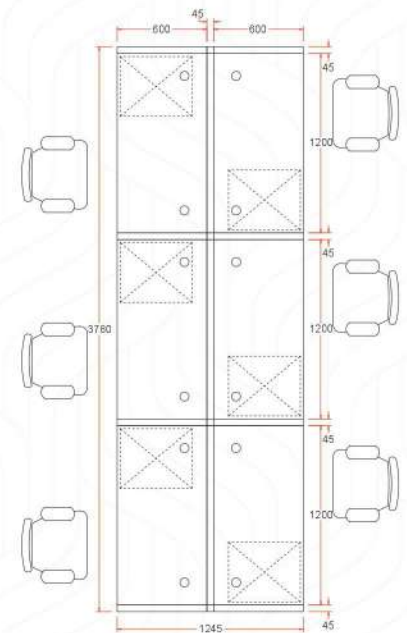

45-R-6

In order to fit your office space, this cluster of 6 meets your requirement to configure your office quintessentially.

60



60-BLOCK DESIGN



60+30-BLOCK DESIGN

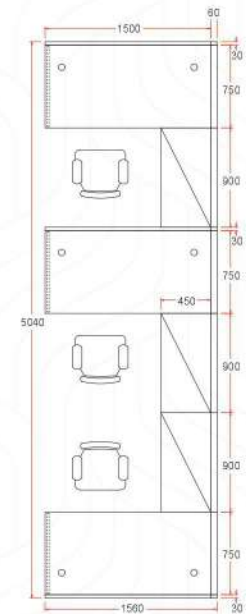
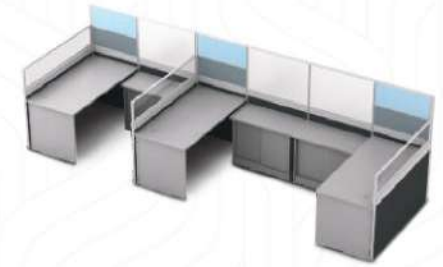
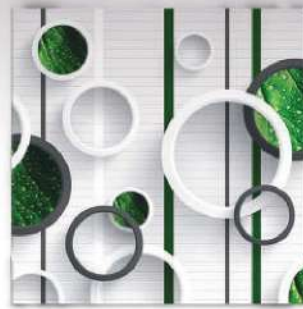

60+30-EXR-3

This workstation solves the issue of space constraint, it allows you to connect and share data with your colleagues.

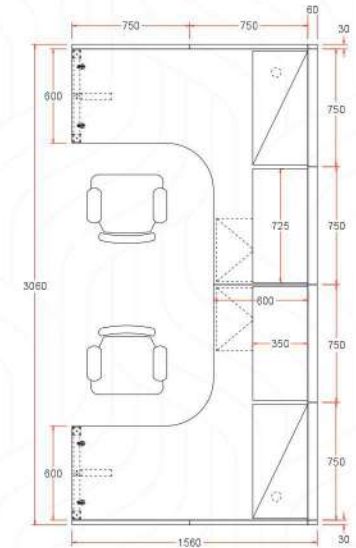

60+30-SL-2

The innovative structure creates a slim look furniture system to compact your space with shelving, cabinets and pedestals.



60+30-SQW-2

The quality workstation designed with latest model of square metal leg makes your workspace easy to access.



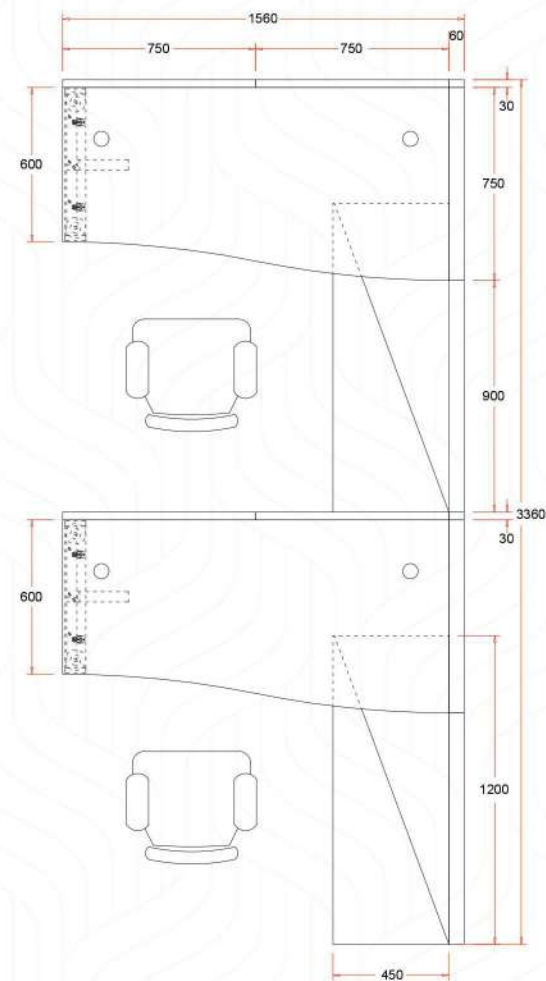
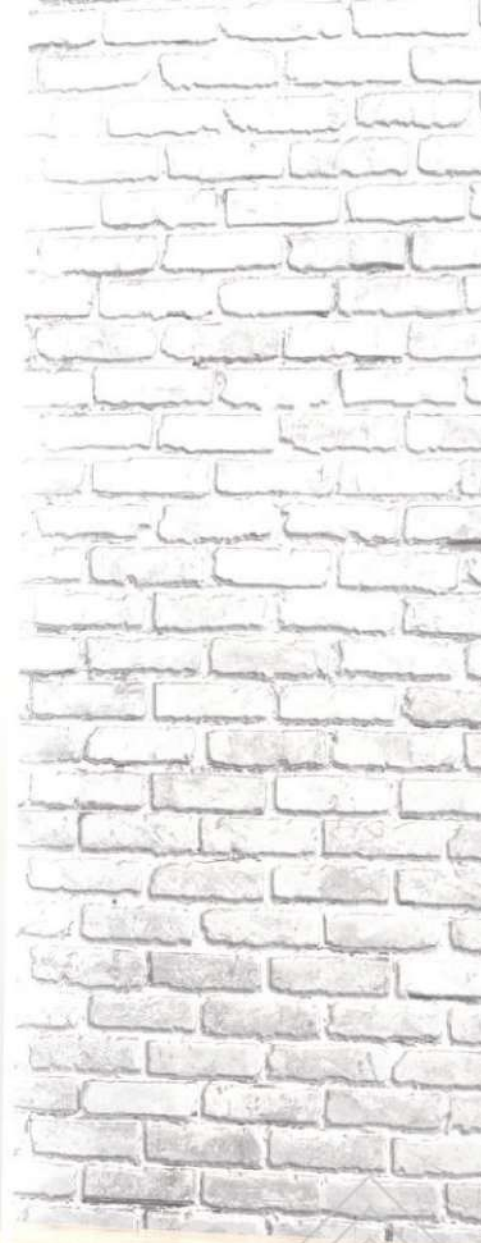

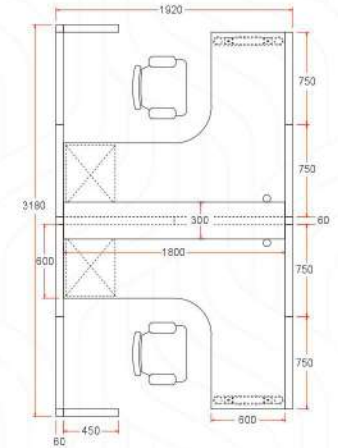

60-HL-2

The stylish block design gives you the aesthetic and practical option that can make your work more visible by creating a team space workplace.

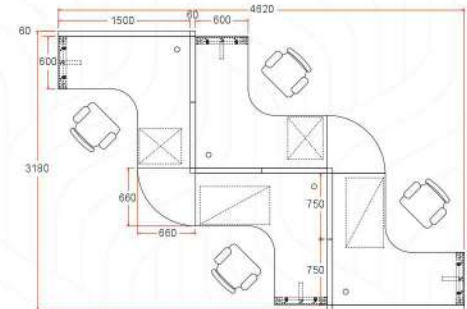

60-SQL-4

The zigzag pattern office system made up of certain corners at variable angles. This contemporary design stimulates smart tasking method.

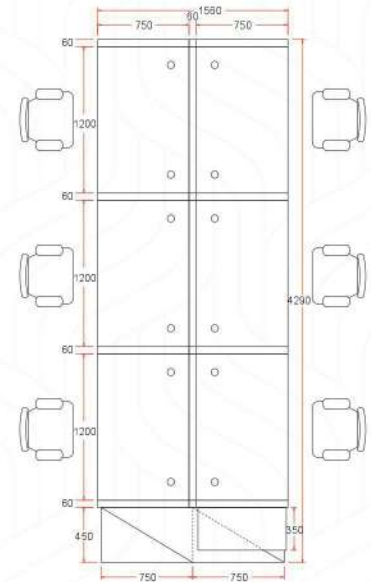

60-R-6

An exceptional square metre considerable for a dozen of partners to work together excellently.

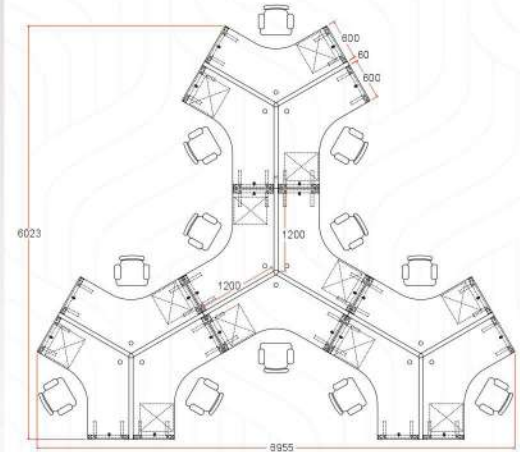
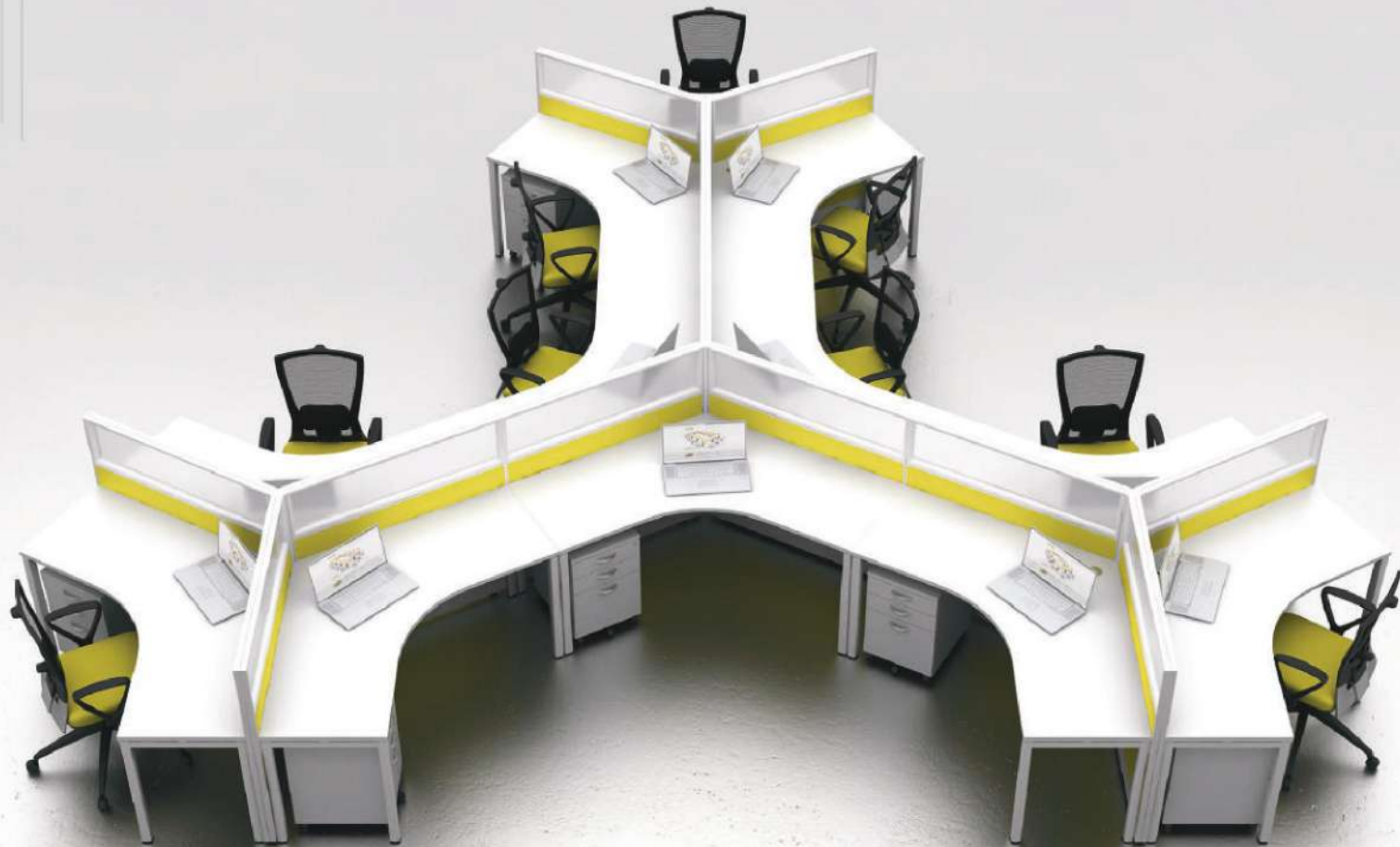

60-SY-12

An office solution that signifies people are working closer, stay connected and having a brainstorming session to produce ideas for an important duty.

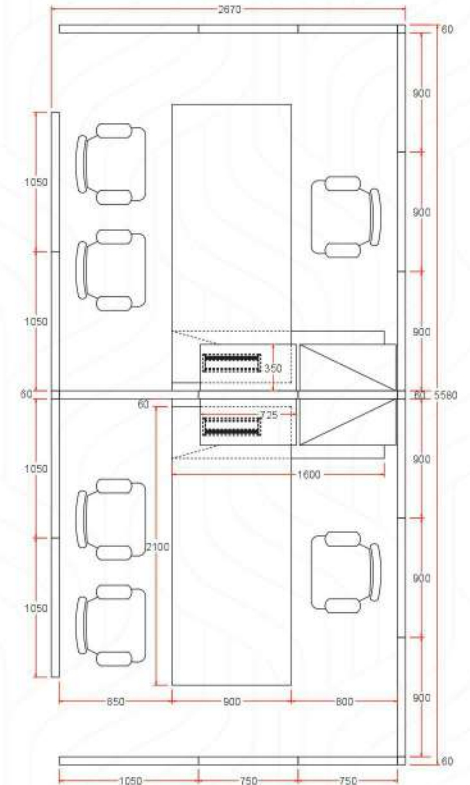

60-C-SR-2

The twin sharing workplace with the cubicle system is designed to enhance the quality of communication for information sharing and support.

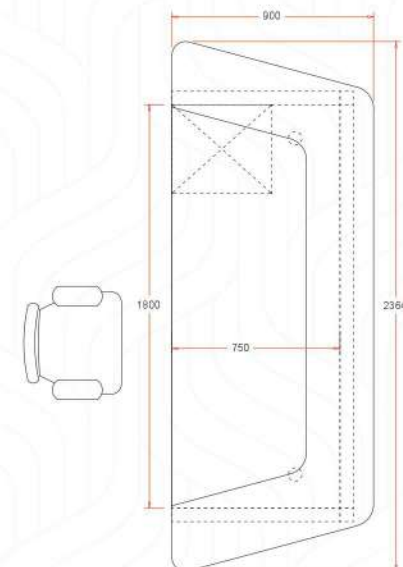

60-REC-1

When you are looking for a modern and compact designed front desk, you can choose our best seller reception counter.

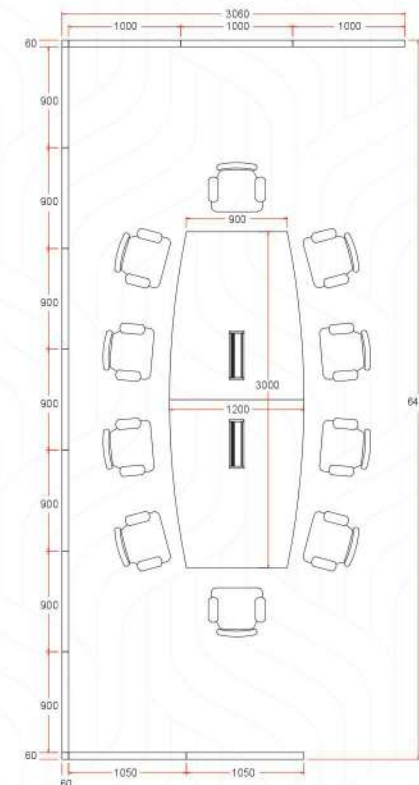

60-C-M

The ceiling height cubicle system makes you feel like having conference in a comfortable room.

BLOCK SYSTEM (THICKNESS : 30MM , 45MM & 60MM)

SOLID PANEL WITHOUT RACEWAY (SP/WR)	2 TONE PANEL WITHOUT RACEWAY (2TP/WR)	3 TONE PANEL WITHOUT RACEWAY (3TP/WR)	HALF (GLASS / POLYCARBONATE) WITHOUT RACEWAY (HG/WR)	HALF (GLASS / POLYCARBONATE) 2 TONE PANEL WITHOUT RACEWAY (HG-2TP/WR)	WHITEBOARD 2 TONE PANEL WITHOUT RACEWAY (WB-2TP/WR)	SOLID PANEL MIDDLE RACEWAY (SP/MR)
3 TONE PANEL MIDDLE RACEWAY (3TP/MR)	HALF (GLASS / POLYCARBONATE) MIDDLE RACEWAY (HG/MR)	HALF (GLASS / POLYCARBONATE) 2 TONE PANEL MIDDLE RACEWAY (HG-2TP/MR)	WHITEBOARD 2 TONE PANEL MIDDLE RACEWAY (WB-2TP/MR)	SOLID PANEL BASE RACEWAY (SP/BR)	2 TONE PANEL BASE RACEWAY (2TP/BR)	3 TONE PANEL BASE RACEWAY (3TP/BR)
HALF (GLASS / POLYCARBONATE) BASE RACEWAY (HG/BR)	HALF (GLASS / POLYCARBONATE) 2 TONE PANEL BASE RACEWAY (HG-2TP/BR)	FULL (GLASS / POLYCARBONATE) BASE RACEWAY (FG/BR)	WHITEBOARD 2 TONE PANEL BASE RACEWAY (WB-2TP/BR)	SOLID PANEL DOUBLE RACEWAY (SP/DR)	HALF (GLASS / POLYCARBONATE) DOUBLE RACEWAY (HG/DR)	2 TONE (GLASS / POLYCARBONATE) BASE RACEWAY (2TG/BR)

PANEL SIZE (H X W)

HEIGHT : 900MM	HEIGHT : 1050MM	HEIGHT : 1200MM	HEIGHT : 1350MM	HEIGHT : 1500MM	HEIGHT : 1650MM	HEIGHT : 1800MM
900 x 450	1050 x 450	1200 x 450	1350 x 450	1500 x 450	1650 x 450	1800 x 450
900 x 600	1050 x 600	1200 x 600	1350 x 600	1500 x 600	1650 x 600	1800 x 600
900 x 750	1050 x 750	1200 x 750	1350 x 750	1500 x 750	1650 x 750	1800 x 750
900 x 800	1050 x 800	1200 x 800	1350 x 800	1500 x 800	1650 x 800	1800 x 800
900 x 900	1050 x 900	1200 x 900	1350 x 900	1500 x 900	1650 x 900	1800 x 900
900 x 1050	1050 x 1050	1200 x 1050	1350 x 1050	1500 x 1050	1650 x 1050	1800 x 1050
900 x 1200	1050 x 1200	1200 x 1200	1350 x 1200	1500 x 1200	1650 x 1200	1800 x 1200
900 x 1350	1050 x 1350	1200 x 1350	1350 x 1350	1500 x 1350	1650 x 1350	1800 x 1350
900 x 1500	1050 x 1500	1200 x 1500	1350 x 1500	1500 x 1500	1650 x 1500	1800 x 1500
900 x 1650	1050 x 1650	1200 x 1650	1350 x 1650	1500 x 1650	1650 x 1650	1800 x 1650
900 x 1800	1050 x 1800	1200 x 1800	1350 x 1800	1500 x 1800	1650 x 1800	1800 x 1800

PANEL OPTIONS

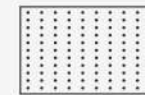

FABRIC BOARD



CLEAR GLASS



POLYCARBONATE



MAGNETIC WHITEBOARD

CUSTOMIZED PANEL



WOOD GRAIN BOARD

60MM PARTITION ACCESSORIES



3 WAY POLE (60-3WP)
4 WAY POLE (60-4WP)



2 WAY POLE
(60-2WP)



120° 3 WAY POLE
(120-3WP)



STABILIZER
(60-SBLZER)



WALL STUD
(60-WS)



END COVER
(60-EC)



POLE COVER
(60-PC)

30MM/60MM PARTITION ACCESSORIES COMBINATION POLE



COMBINATION POLE 30/60
(CP-30/60)

45MM PARTITION ACCESSORIES



2 WAY POLE (45-2WP)
3 WAY POLE (45-3WP)
4 WAY POLE (45-4WP)



WALL STUD
(45-WS)



END COVER
(45-EC)



COUNTER TOP BRACKET
(30/45/60-CTB)



POLE COVER
(45-PC)



STABILIZER
(30/45-SBLZER)

30MM PARTITION ACCESSORIES



NEW POLE
2 WAY POLE (30NP-2WP)
3 WAY POLE (30NP-3WP)
4 WAY POLE (30NP-4WP)



UNIVERSAL POLE
2 WAY POLE (30-2WP)
3 WAY POLE (30-3WP)
4 WAY POLE (30-4WP)



END COVER
(30-EC)



POLE COVER
(30-PC)

HANGING SYSTEM (THICKNESS : 30MM)



**SOLID PANEL
WITHOUT RACEWAY**
(30SP/WR)



**HALF (GLASS / POLYCARBONATE)
WITHOUT RACEWAY**
(30HG/WR)



**SOLID PANEL
MIDDLE RACEWAY**
(30SP/MR)



**HALF (GLASS / POLYCARBONATE)
MIDDLE RACEWAY**
(30HG/MR)

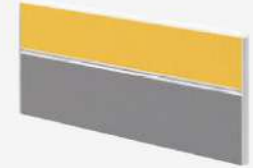

**2 TONE PANEL
WITHOUT RACEWAY**
(30-2TP/WR)

30MM HANGING SYSTEM BRACKET



METAL PLATE (30MM)
(30-MP) 100W x 50D x 2THK

30-MP QTY	
PANEL SIZE	QTY
200mm-900mm	2 PCS
901mm-1200mm	3 PCS
1201mm-1800mm	4 PCS

30MM PANEL SIZE LAYOUT

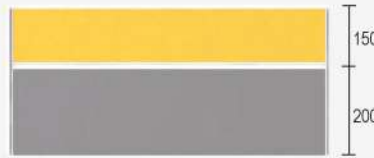

HEIGHT : 350MM (WR)



HEIGHT : 350MM (MR)



HEIGHT : 400MM (WR)

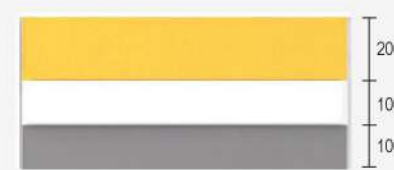

HEIGHT : 400MM (MR)

HEIGHT : 350MM		HEIGHT : 400MM	
350 x 600	350 x 1200	400 x 600	400 x 1200
350 x 750	350 x 1350	400 x 750	400 x 1350
350 x 800	350 x 1500	400 x 800	400 x 1500
350 x 900	350 x 1650	400 x 900	400 x 1650
350 x 1050	350 x 1800	400 x 1050	400 x 1800

PARTITION FRAME COLOUR OPTIONS



DARK GREY



SILVER



LIGHT GREY



WHITE

HANGING & DESKING SYSTEM (THICKNESS : 18MM)



**SOLID PANEL
WITHOUT RACEWAY**
(18SP/WR2) 4 Sided Frame
(18SP/WR) 3 Sided Frame



**HALF (GLASS / POLYCARBONATE)
WITHOUT RACEWAY**
(18HG/WR2) 4 Sided Frame
(18HG/WR) 3 Sided Frame



**FULL GLASS
WITHOUT RACEWAY**
(18FG/WR2)
(Panel Height : 300/450mm)



**FULL POLYCARBONATE
WITHOUT RACEWAY**
(18FP/WR2)
(Panel Height : 300/450mm)



**2 TONE PANEL
WITHOUT RACEWAY**
(18-2TP/WR2) 4 Sided Frame
(18-2TP/WR) 3 Sided Frame



**WHITEBOARD
WITHOUT RACEWAY**
(18WB/WR2) 4 Sided Frame
(18WB/WR) 3 Sided Frame

18MM PANEL SIZE LAYOUT

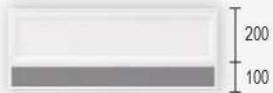

HEIGHT : 300MM



HEIGHT : 600MM



HEIGHT : 450MM

PANEL SIZE (H x W)

HEIGHT : 300MM		HEIGHT : 450MM		HEIGHT : 600MM	
300 x 600	300 x 1200	450 x 600	450 x 1200	600 x 600	600 x 1200
300 x 750	300 x 1350	450 x 750	450 x 1350	600 x 750	600 x 1350
300 x 800	300 x 1500	450 x 800	450 x 1500	600 x 800	600 x 1500
300 x 900	300 x 1650	450 x 900	450 x 1650	600 x 900	600 x 1650
300 x 1050	300 x 1800	450 x 1050	450 x 1800	600 x 1050	600 x 1800

18MM PARTITION ACCESSORIES



POLE BRACKET END (B)
(PB-E-B) 45W x 24D x 80H
(Panel Height : 300/450mm)



POLE BRACKET MIDDLE (B)
(PB-M-B) 45W x 24D x 80H
(Panel Height : 300/450mm)



POLE BRACKET END (S)
(PB-E-S) 45W x 17D x 80H
(Panel Height : 300/450mm)



**CONNECTING POLE C/W
PLATE**
(18-PP)



ATTACHED BRACKET
(18-AB)



METAL L BRACKET
(18-MLB) 50W x 25D x 50H
(Panel Height : 450/600mm)

CLIP DESIGN (THICKNESS : 16MM)



16SP	
PANEL SIZE (HxW)	
HEIGHT: 300MM	
300 x 450	300 x 1200
300 x 600	300 x 1350
300 x 750	300 x 1500
300 x 800	300 x 1650
300 x 900	300 x 1800
300 x 1050	

SANDBLAST GLASS (THICKNESS : 6MM)



6STG	
SANDBLAST TEMPERED GLASS SIZE (HxW)	
HEIGHT: 300MM	
300 x 1050	
300 x 1350	
300 x 1650	

DESKING SYSTEM SANDBLAST GLASS BRACKET



BLOCK PANEL BRACKET (END)
(6/18 BP-E) 55W x 35D x 105H



BLOCK PANEL BRACKET (MIDDLE)
(6/18 BP-M) 90W x 35D x 105H

ACCESSORIES



**CANTILEVER
BRACKET-LEFT / RIGHT**
(CB)-L/R 460W x 30D x 190H



**CANTILEVER
BRACKET-MIDDLE**
(CB-M) 460W x 60D x 190H



**UNIVERSAL
BRACKET-LEFT / RIGHT**
(UB)-L/R 79W x 49D x 85H



**GABLE END
BRACKET-LEFT / RIGHT**
(GEB)-L/R 35/25W x 85H



**OPEN SHELF
BRACKET-LEFT / RIGHT**
(OSB)-L/R 204W x 25D x 200H



**VERTEBRAL FLOOR
WIRE HOLDER**
(VFWH)



WIRE TRAY
(WT 800) 802W x 190D x 70H



**WOODEN HANGING BRACKET
(CHROME)**
(MP-B) 100W x 50D x 122H



METAL FRONT PANEL
(MP 1300) 1000W x 26D x 380H
(MP 1500) 1200W x 26D x 380H
(MP 1800) 1500W x 26D x 380H

VIO LEG SERIES



VIO LEG
(105-SGL) 160W x 175D x 725H



VIO ADJUSTABLE LEG
(106-SGL) 160W x 175D x 725H

TOWER LEG SERIES



NON HEIGHT ADJUSTABLE LEG
(45X-SL) 525/620W x 700H



CANTILEVER BRACKET
(45X-CBS) 265W x 68D x 68H



MIDDLE CONNECTING BRACKET
(45X-MCB)



ABS BRACKET
(45X-ABS) 122W x 52D x 35H



FIXED TRUNKING
(45X-T1500) 1333W x 80D x 70H
(45X-T1800) 1633W x 80D x 70H
(45X-T3000) 2833W x 80D x 70H



FIXED SR TRUNKING
(45X-SR1500) 1029W x 80D x 70H
(45X-SR1800) 1329W x 80D x 70H

PYRAMID LEG SERIES



PYRAMID LEG
(130-PL) 77W x 41D



**CONNECTING BRACKET
3-WAY-LEFT
(CHROME)**
(130-B-3LWL)



**CONNECTING BRACKET
3-WAY-RIGHT
(CHROME)**
(130-B-3RWL)



**CONNECTING BRACKET
3-WAY-NEW
(CHROME)**
(130-B-3NW)



**CONNECTING BRACKET
1-WAY
(CHROME)**
(130-B-1W)



**CONNECTING BRACKET 3-WAY
(CHROME)**
(130-B-3W)



**CONNECTING BRACKET-LEFT
(CHROME)**
(130-B-L)



**CONNECTING BRACKET-RIGHT
(CHROME)**
(130-B-R)



**CONNECTING BRACKET-BASE
(CHROME)**
(130-B-BASE)



L BRACKET
(130-LB) 53W x 21D



ADJUSTABLE LEG
(130-B-ADJ)

PANEL HEIGHT : 30MM, 45MM & 60MM

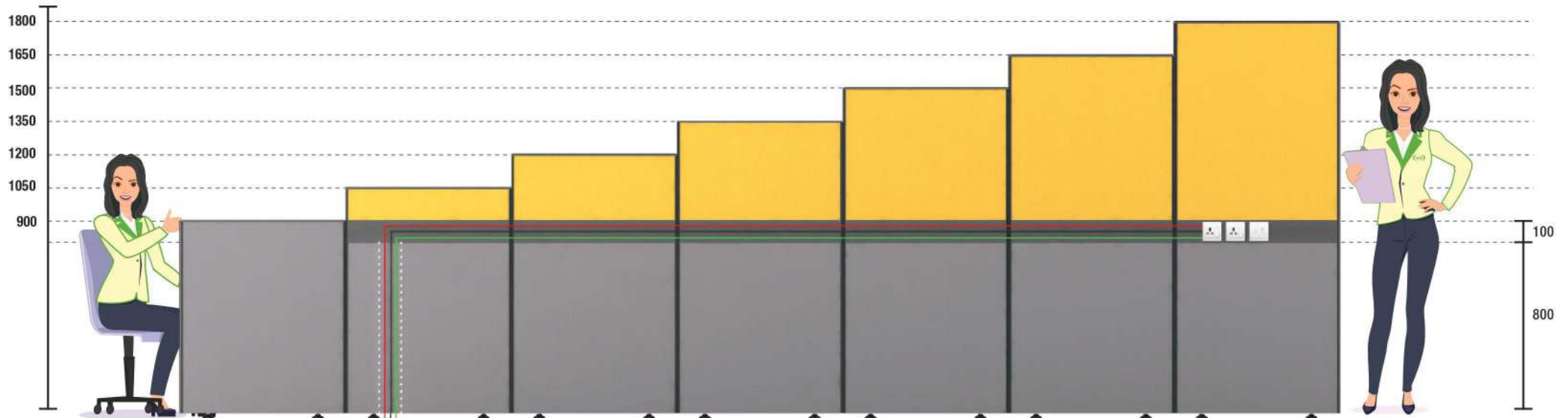

WIRE TUNNEL :

1. Allow wire go through inside panel from floor to raceway
2. Wire tunnel to be opened upon request (standard size: 100mm)
3. Wood grain panel for 30mm & 45mm are **NOT ALLOWED** to open.

OFFICE PARTITION STRUCTURE SYSTEM

- PANEL LEG
- J LEG
- PYRAMID LEG
- O LEG



- SL LEG
- SQ LEG
- TOWER LEG
- VIO LEG
- VIO ADJUSTABLE LEG